

Universal IV™ Series Pro and Lite Models

RF Admittance/Capacitance Continuous Level Measurement System



The Universal IV™ Series is the fourth generation RF continuous system built on Drexelbrook's 50 years of experience in level measurement. The product is backward compatible with the industry standard Universal III™, Universal Lite™, Universal II™ and RCT™ Series and is the ideal solution for a wide array of applications. A few enhancements to the Universal IV Series include worldwide hazardous location approval, standard display/keypad, autoranging capabilities and state of the art stable and accurate measurement.

Pro Model

The Universal IV™ Pro model integrates the RF Admittance technology pioneered by Drexelbrook with the versatility of Cote-Shield™ technology that ignores coatings on the probe and measurement span of 1" to 800'. The Pro is compatible with a vast array of applications: conductive, insulating, and heavy or light coating.

Lite Model

The Universal IV™ Lite model is the entry level RF Capacitance measurement system without Cote-Shield™ capabilities. Lite models can be used in non-coating conductive liquids and insulated coating applications where Cote-Shield™ is not required. In addition, the Lite model offers a measurement range up to 20' typically.

Features and Benefits:

- Proven Drexelbrook level solution for the most common to the most challenging applications
- The most versatile level technology for liquids, slurries, interface and granules measurement
- Over 125 probe types for a wide array of applications, flex, rigid, wetted materials and process connections
- 2-wire, 4-20mA loop transmitter with the widely accepted digital HART protocol
- Process temperature from cryogenic to 1000°F (537°C)
- Process pressure from vacuum to 10,000 PSI (690 BAR)
- Measurement span as short as 1" (25mm) to 800 ft (244m), no dead zone or blocked measurement areas
- Proven Cote-Shield™ technology that ignores coating build-up on the probe
- Immune to vapor, dust and foam interference
- Immune to tank obstructions such as nozzles, ladders, pipes and agitators
- Low cost of ownership, no maintenance, and no moving parts to wear out
- Stable, repeatable, and accurate measurement within 0.25% of range
- Built-in isolation and surge protection for increased reliability
- Easy one-time calibration, configure it once and go
- Free PC-based HRTWIN™ configuration software for initial setup from anywhere on the loop or a handheld HART@communicator can be used
- Standard user friendly push-button LCD display for configuration and monitoring
- Integral and remote installation. The transmitter can be integrated with the probe, or for harsh environmental conditions it can be installed remotely away from the probe/vessel
- Worldwide approvals: FM, FMc, ATEX, IECEx and CE mark
- Hazardous location approvals, Intrinsic Safety (IS) and Explosion Proof/Flameproof for Class I, Div I, and Zone 0 installations
- Fully backward compatible with Drexelbrook's leading products such as Universal III, Universal Lite and RCT series
- 50+ years of Drexelbrook applications knowledge that ensures the right solution for your application

Universal IV™ Series Pro and Lite Models

One of the Drexelbrook's key advantages is applications expertise. Drexelbrook offers more than products, we offer solutions that work. Our team of applications engineers will assist you with the ideal solution that solves your problem. The Universal IV can be successfully applied across various industries including: oil & gas, chemical, petrochemical, water & wastewater, power, food & beverage, pharmaceutical, pulp & paper, mining & aggregates, feed & grain and much more. Below are some typical applications examples.

Typical Level Monitoring and Control

Integral vs. Remote configuration

In integral configuration, the transmitter with display/keypad is mounted directly on the probe which is inserted in the vessel. The 2-wire 4-20mA output is typically monitored by a DCS/PLC system in the control room. In remote configuration the display/keypad is typically installed beside the vessel and is connected to the probe remotely via the remote cable. Remote installations are recommended in harsher environments where temperature and pressure extremes exist or for operator convenience and safety.

Applications Examples

Oil and Gas Refining

Desalter / Dehydrators and electrostatic separators

Oil/water separators are commonly used in the refining process to improve oil quality, control water dump and maximize throughput. A typical separator contains four phases: oil on top, water and sediment at the bottom and a two-part emulsion phase in-between. The Universal IV Pro model accurately and reliably measures the electrical interface within the emulsion layer even in upset conditions. The Universal IV allows operators to keep this electrical interface at an optimum distance from the electrostatic grid to maximize efficiency and throughput.

Molten Sulfur

Sulfur removal is a common application in oil and gas refining. Sulfur is a byproduct of removing sulfur-containing contaminants from natural gas and petroleum. The molten sulfur is an insulating liquid that can leave significant coating deposits on the sensor as the temperature of the sulfur may vary. The sulfur coatings are electrically insulating and easy to ignore for RF Admittance and RF Capacitance technologies. A 3-terminal Cote-Shield sensor allows the level measurement system to remain unaffected by coating deposits and ambient temperature variations.

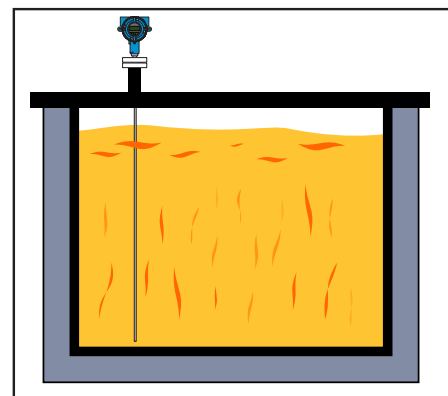
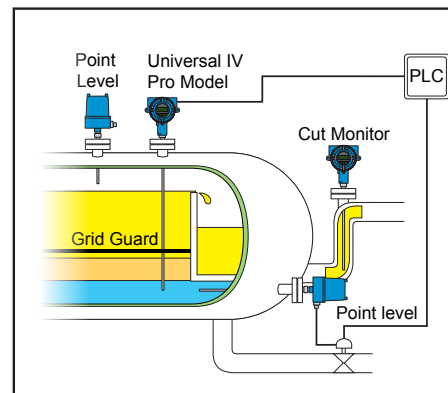
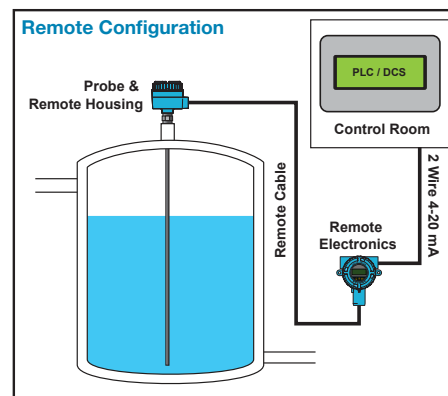
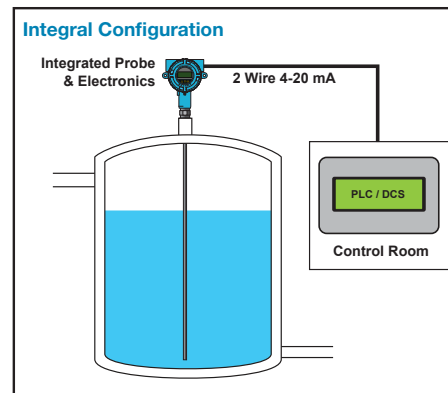

Universal IV™ Series Pro and Lite Models

Applications Examples (Continued)

Water and Wastewater

Digesters

Digesters are commonly used in sewage treatment plants to limit access to oxygen and encourage the generation of methane and carbon dioxide by microbes in the waste. Aerobic and anaerobic digestion is used to decompose organic matter to reduce volume. In some instances the Digester may be a floating roof tank. As the digestion process takes place and the bio-gas is generated, a floating roof tank may be utilized that will allow the user to contain and monitor the amount of bio-gas that is created above the sludge level. The Universal IV Pro model would be the technology of first choice. With the use of a flexible cable sensor we can either measure the level of the digester and ignore the heavy foam build-up on the sensor, or mount to the floating roof and measure the bio-gas volume above the digester level. Probe model 700-0005-018 has many years of proven history in these applications.

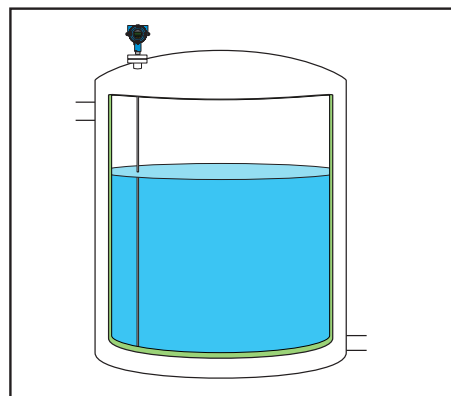
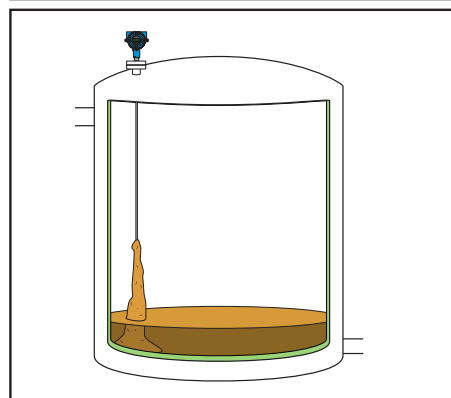
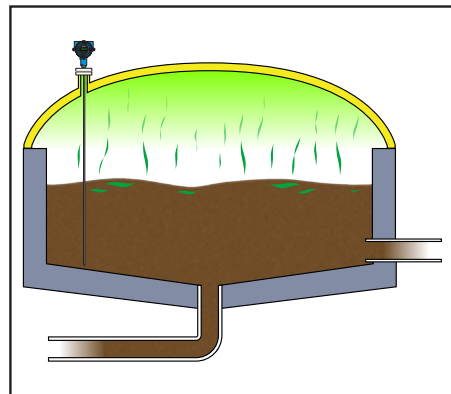

Equalization tanks

Equalization tanks collect water, wastewater, recycled water from wastewater streams, microfiltration systems, reverse osmosis systems and others. This water typically has a high concentration of manganese, iron, chlorine and other chemicals that builds up heavily on the probe. The Universal IV Pro is the ideal solution for this application due to its ability to reject build up on the probe and its immunity to heavy water flows and agitation.

Pharmaceutical / Biotech







De-Ionized Water

De-Ionized Water (DI Water) Level Measurement and Control requires an understanding of the measurement parameters and level technology. DI Water conductivities commonly range from 1 – 10 micromhos / microsiemens or more. Simple capacitance level systems “drift” with normal variations in DI Water conductivity. Conductance technologies are misled by the extremely low conductivity of DI Water. Drexelbrook RF systems will accurately, reliably and repeatedly make DI Water measurements without “drift” by the correct selection of the electronic module frequency and sensing element. Performance is unaffected by variations in DI Water conductivity variations. Drexelbrook has successfully made this difficult measurement for over 40 years in the medical, pharmaceutical and biotech industries.

Universal IV™ Series Pro and Lite Models







Probe Selection

The Universal IV™ Series has one of the richest and most versatile probe selections in the industry. Over 125 probes can be selected as a standard option in the Universal IV model number and many special probes can be customized upon request. Drexelbrook's bonded probe construction ensures the highest probe quality and measurement reliability. This table summarizes a few commonly used probes. Our applications engineers can assist you with the selecting the right probe for your application.

Probe Model	Picture	Typical Applications	Construction / Wetted Material	Maximum Temperature °F	Maximum Pressure PSI	3-Digit SE Model Code
700-0001-022		General purpose, non-coating conductive liquids, low viscosity	3/8" OD, PTFE covered rod	100 300	1000 500	301
700-0001-026		General purpose, non-coating insulating liquids, low/medium viscosity for non-linear ground reference	3/8" OD PTFE covered rod with 1.66" OD perforated carbon steel concentric shield	100 300	1000 500	303
700-0001-344		Conductive or insulating corrosive liquids with linear ground reference	3/8" OD PFA insulated SealTyte™ rod with PFA faced flange	100 350	1000 500	308
700-0002-024		High temp non-coating liquid, interface, low viscosity	3/4" OD PTFE insulated rod	100 450	1000 500	311
700-0002-027		Heavier coating conductive liquids or Interface measurement	1/2" FEP insulated rod	100 300	1000 500	312
700-0002-037		Heavier coating, liquids, slurry, interface	1/2" OD PVDF insulated rod	100 250	1000 500	603
700-0002-057		Coating liquids and slurries and interface. Good strength and abrasion resistance	0.84" OD PVDF insulated rod.	100 250	1000 500	606

Universal IV™ Series Pro and Lite Models

Probe selection (Continued)

Probe Model	Picture	Typical Applications	Construction / Wetted Material	Maximum Temperature °F	Maximum Pressure PSI	3-Digit SE Model Code
700-0002-224		Electrostatic desalters, High temp, remote only	3/4" OD PTFE insulated rod	100 450	1000 500	612
700-0005-018		Flex cable for coating liquids, slurries, granulars and interface. Agitated service when anchored	5/16" PVDF insulated flexible cable	100 250	1000 500	713
700-0005-019		Heavy duty for coal, ores and other abrasive material	Urethane insulated flexible cable with special impregnation	150	5	716
700-0005-054		Coating applications, thin cable	0.093" OD PFA insulated cable	300	500	318
700-0005-085		With integral ground for non metallic vessels, coating liquids	0.185" OD FEP insulated flexible cable	200	200	719
700-0205-078		Insulating and conductive granular	5/16" OD PVDF insulated 3-terminal flexible cable with anchor and slack adjuster.	100 250	1000 500	747
700-1202-001		Insulating liquids, and solids, general purpose, remote only	3/8" OD 316L SS with PEEK insulation	100 450	1000 200	101

A wide array of process connections are also available including NPT, BSP, Flange (ANSI, DIN, JIS), Tri clamp, Grayloc and much more to comply with international standards that fit your applications. More wetted materials such as 316LSS, Hastelloy C-276, Monel, Alloy 20, PTFE, FEP, PFA grade Teflon®, Urethane, Polyurethane, PVDF, and other commercially available materials on request.

Universal IV™ Series Pro and Lite Models

Integral Mounting / Dimensions - inches (mm)

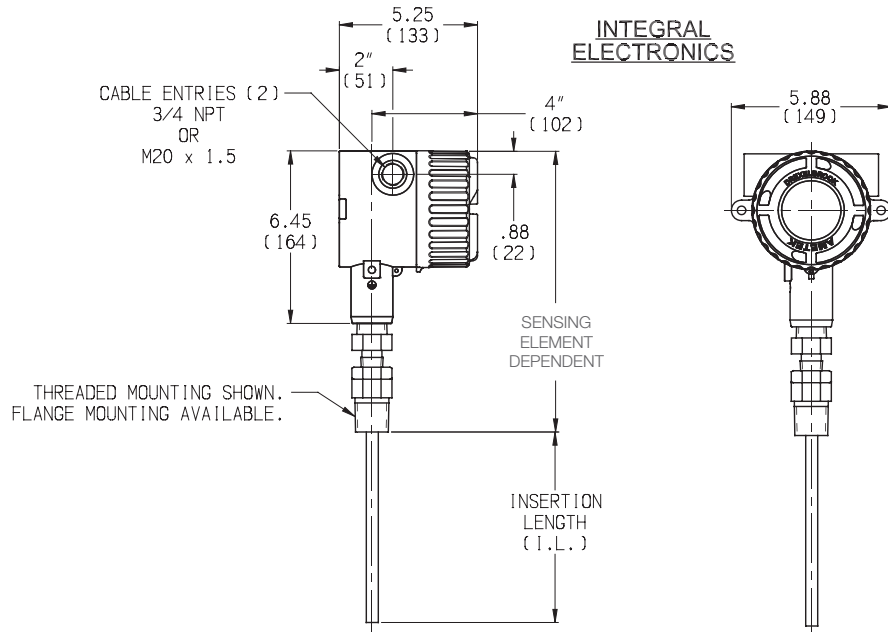

Remote Mounting / Dimensions - inches (mm)

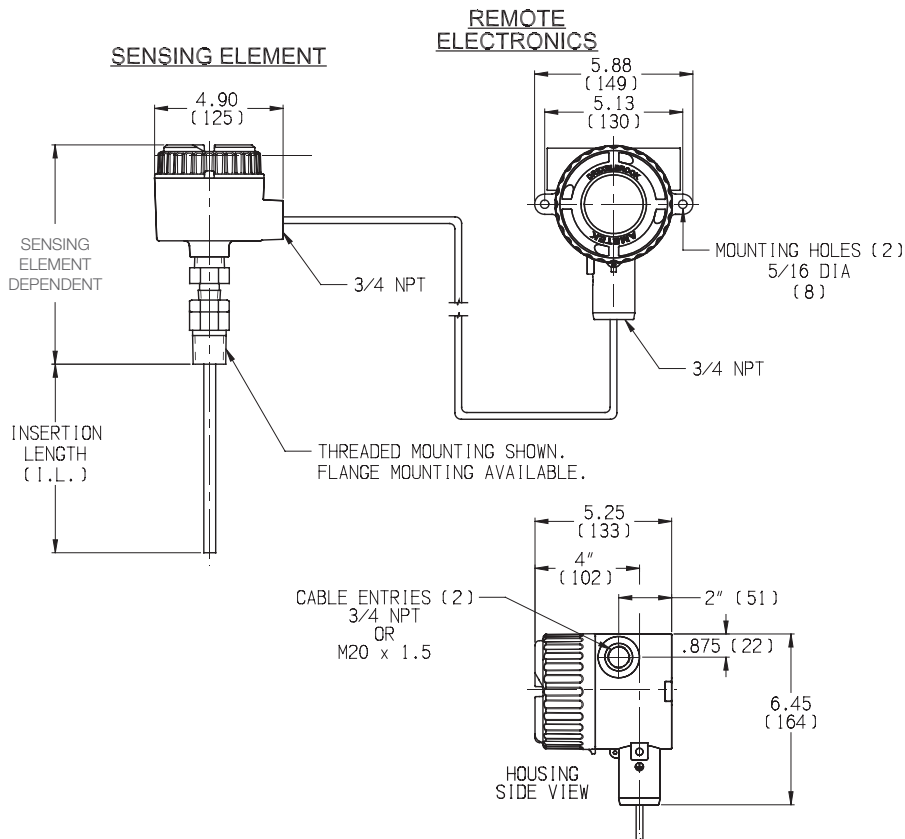

Universal IV™ Series Pro and Lite Models

Backward Compatibility

Drexelbrook has installed countless RF continuous level systems in the field over the past 50 years. We ensure our customers with existing installations are fully supported with a seamless migration path to new products and spares. The Universal IV™ Series is fully compatible with its predecessors such as: the Universal Lite™, Universal III™, and RCT™. Furthermore, all probes (models 700-xxxx-xxx) are common across all of Drexelbrook's RF products. Therefore, the migration to the Universal IV™ Series is seamless and transparent to the user.

Universal IV™ System Replaces the Universal III™, Lite™ and RCT™

The following table summarizes some common Universal IV system part numbers and their equivalent predecessors.

New Universal IV™ Series			Existing Products Universal III™, Lite™ and RCT™	
Model	Part #	Description	Model	Part #
Pro Model	UP01010000-xxx*	RF Admittance, 100 Khz, 0° Phasing, 1-45,000 pF span FM IS approval Integral	Universal III	509-0075-9xx 409-1000-F09-00
			RCT	RCT121F00xx
Pro Model	UP21010000-xxx	RF Admittance, 100 Khz, 45° Phasing, 1-45,000 pF span FM IS approval Integral	Universal III	509-0075-9xx 409-1030-F09-00
			RCT	RCT131F00xx
Pro Model	UP11010000-xxx	RF Admittance, 15 Khz, 0° Phasing, 1-45,000 pF span FM IS approval Integral	Universal III	509-0015-9xx 409-1000-F19-00
			RCT	N/A
Pro Model	UP31010000-xxx	RF Admittance, 15 Khz, 45° Phasing, 1-45,000 pF span FM IS approval Integral	Universal III	509-0015-9xx 409-1030-F19-00
			RCT	N/A
Lite Model	UL01010000-xxx	RF Capacitance, 100 Khz, 0° Phasing, 20-7,000 pF span FM IS approval Integral	Universal Lite	509-0016-9xx 409-1400-F09-0
Lite Model	UL11010000-xxx	RF Capacitance, 15 Khz, 0° Phasing, 20-7,000 pF span FM IS approval Integral	Universal Lite	509-0015-9xx 409-1400-F19-0

* XXX = 3 digit probe model number

Electronics Upgrade Kit for Existing Systems

Leave Your Probe in the Tank and Upgrade Your Electronic Housing

To upgrade your existing Universal Lite, Universal III or RCT system you don't have to remove the probe from the tank. Just remove the old housing and mount the new Universal IV Housing on your existing probe.

You don't even have to know the probe model number. The universal retrofit kit model 'R00' includes all necessary adapters for all possible connections to the probe.

Order your retrofit kit as follows: Model # Unn1010000-R00 'nn' can be P0, P2, P1, P3, L0 or L1 to match your existing '409' electronics according to the table above.



Universal IV™ Series Pro and Lite Models

Specifications

Technology

RF Admittance / Capacitance

Supply Voltage

13-30VDC, 2-wire loop powered

Output/Digital Protocol

4-20mA, HART

Compatible with HART®

HART device description available

Load Resistance

Maximum 550 ohms at 24 VDC

Minimum 250 ohms for HART protocol

Ambient Temperature

-40°C to 75°C (-40°F to 167°F)

Process Temperature

-106°C to 815°C (-160°F to 1500°F), probe dependent

Process Pressure

Vacuum to 1350 bar (20,000 psi), probe dependent

Process Connection

NPT, BSP, JIS, ANSI, DIN, Grayloc, Tri-Clamp, Perlick Fitting and more upon request

Main Wetted Parts

316L, PVDF, TFE, FEP, PFA, HastelloyC, Monel and more depending on applications requirements. Consult factory

Sensor Length

1" to 800 Feet (25.4mm to 244m)

Probe, Pro and Lite model dependent

Capacitance Measurement Range

Autoranging (6 ranges)

1-45,000 pF (Pro model)

20-7,000 pF (Lite model)

Cote-Shield™

Pro model: Coating rejection with 100Khz or 15Khz and 45° phasing

Lite model: 100Khz or 15Khz without phasing for insulating coating or conductive non-coating applications only

Integral or Remote Configuration

100 ft max cable length for remote configuration

Accuracy

0.25% of span (ranges 2-6)

Includes the effects of linearity, hysteresis and repeatability on electronics only

Response Time to Level Changes

350 msec nominal (no damping applied)

1-90 seconds programmable damping time

Supply Voltage Effect

0.2% of full scale max

Temperature Effect

0.5% per 100°F (37.7°C) change

Start-Up Time

< 12 seconds

Configuration and Calibration

Standard LCD display and keypad on all models

HRTWIN™ PC-based software

Or third party Model 275, 375, 475 handheld communicator

Emission and Surge Protection

Compliant with IEC6100-4.2, 3, 4, 6, 8

Compliant with CISPR11 Group I, Class B

Approvals

Intrinsically Safe (IS)

Explosion Proof (XP) without IS barrier

FM, FMc, ATEX, IECEx

CE Mark



Universal IV™ Series Pro and Lite Models

Model Numbering



Universal IV™ Series Pro and Lite Models

Model Numbering (Continued)

